

- (D)** Einbauanleitung / nur Händlereinbau
- (GB)** Installation instructions / Dealer installation only
- (F)** Consignes de montage / Montage uniquement par le concessionnaire
- (NL)** Montagehandleiding / Montage alleen door dealers
- (DK)** Montagevejledning / Montage kun hos forhandleren
- (N)** Monteringsinstruksjon / Montasje kun hos forhandleren
- (S)** Installationsanvisning / Får endast monteras av återförsäljaren
- (FIN)** Asennusohje / Asennus vain myyntiliikkeen toimesta
- (I)** Istruzioni per il montaggio / Installazione solo presso la concessionaria
- (E)** Instrucciones de montaje / Instalación exclusiva por el distribuidor
- (P)** Instruções de montagem / Montagem só no concessionário
- (GR)** Οδηγίες εγκατάστασης / Συναρμολόγηση μόνο από εμπόρους
- (CZ)** Návod k montáži / Montáž pouze prodejcem
- (PL)** Instrukcja montażu / Montaż tylko u dealera
- (TR)** Montaj talimatı / Sadece satıcı tarafında monte edilir
- (H)** Beépítési útmutató / Csak a kereskedő építeti be
- (HR)** Upute o ugradnji / Ugradnja samo od strane trgovca
- (BUL)** Инструкция за монтаж / Монтажът може да се извърши само от търговеца
- (RO)** Instrucțiuni de montaj / Se va monta numai de către dealer
- (RUS)** Инструкция по монтажу и установке / Устанавливать только у дилера
- (LT)** Montavimo informacija / Montuoja tik prekybininkas
- (LV)** Iemontēšanas pamācība / Tikai pārdevēja iebūve
- (EST)** Paigaldusjuhend / Paigaldab ainult müüja
- (SLO)** Navodilo za vgradnjo / Vgradnja le od trgovca
- (SK)** Montážny návod / Montáž iba obchodníkom
- (J)** 取り付け説明書 / 販売業者取り付けのみ
- (ROK)** 장치 지시사항 / 오직 전문상인이 장치
- (THA)** คู่มือการติดตั้ง / ติดตั้งโดยตัวแทนจำหน่ายเท่านั้น
- (VR)** 安装说明书 / 仅供销售商安装用
- (VR)** 安裝說明書 / 僅供銷售商安裝用

Opel Automobile GmbH

D-65423 Rüsselsheim, Germany



13 370 761



2 - 7

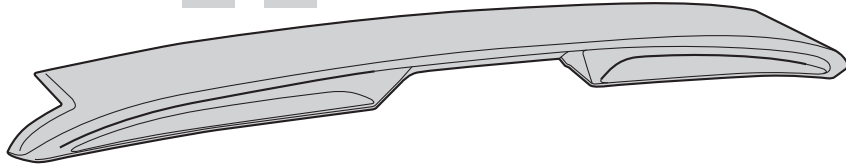

39 118 114

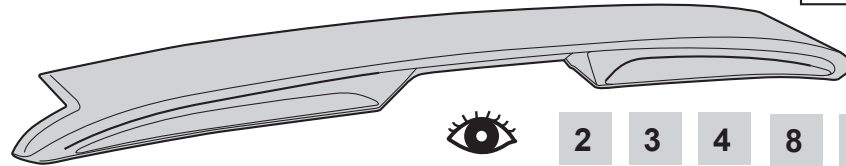
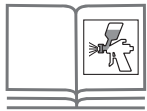

2 3 4 8 9 10

2

95 599 786



9121520

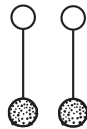

9163368



9121519

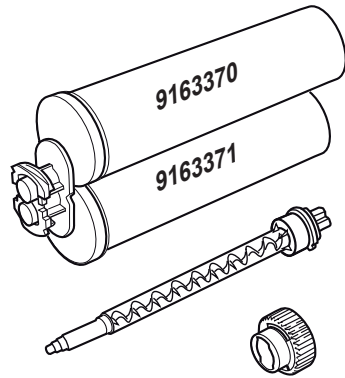

3

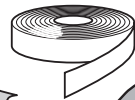
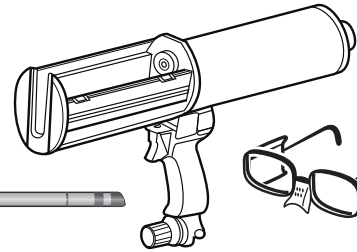

4

